

1 UPS Solar 25-120 180



: [52588352](#)

UPS Solar

- *
- *
- *
- *
- *
- *

UPS Solar

: 2 .. 95 °C
 : 60 °C
 : 983.2 / ³

TF : 95
 : CE,EAC

EN-JL1030
 ASTM 30 B
 , PES/PP

: 0 .. 40 °C

: 95 %
 : 10
 : G 11/2
 : 180

-P1: 180 .. 230
2: 180
: 230
: 50 Hz
: 1 x 230
2: 0.79 A
3: 1.01 A
: 0.79 .. 1.01 A
- : 6
(IEC 34-5): X2D
(IEC 85): F
: 2.6
: 2.8
: 0.004³
Danish VVS No.: 380591121
C : RS
: 8413703000

52588352 UPS Solar 25-120 180 50

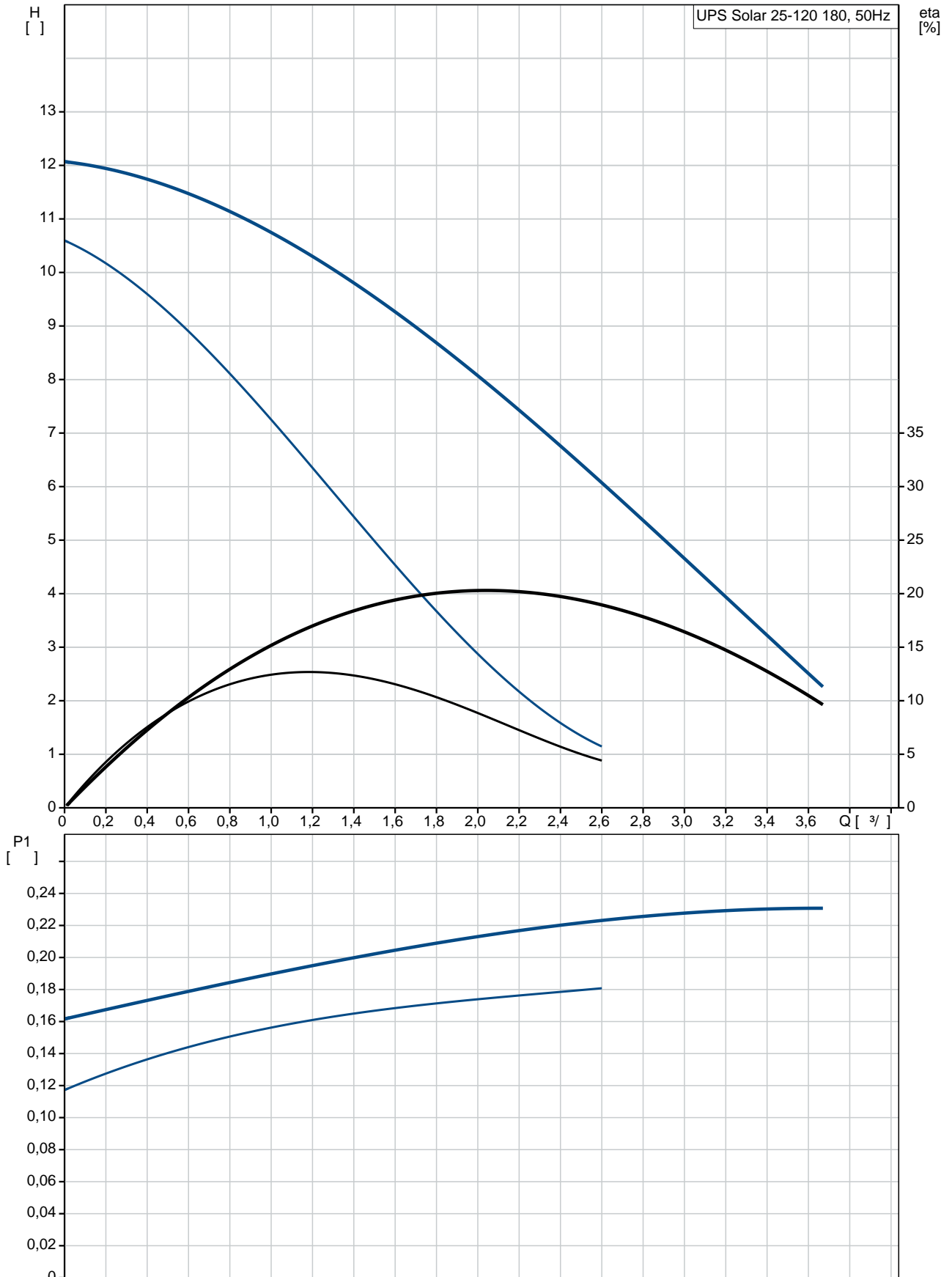

	UPS Solar 25-120 180
	52588352
EAN	5700394931205
	2
	120
TF	95
	CE,EAC
	EN-JL1030 ASTM 30 B , PES/PP
	0 .. 40 °C
	95 %
	10
	G 1 1/2
	180
	2 .. 95 °C
	60 °C
	983.2 / ³
-P1:	180 .. 230
2:	180
	230
	50 Hz
	1 x 230
2:	0.79 A
3:	1.01 A
	0.79 .. 1.01 A
	6
(IEC 34-5):	X2D
(IEC 85):	F
	CONTACT
	9H
	2.6
	2.8
	0.004 ³
Danish VVS No.:	380591121
C	RS
	8413703000

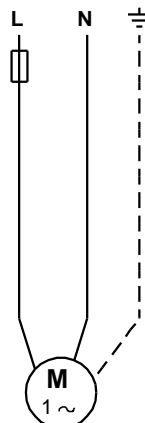
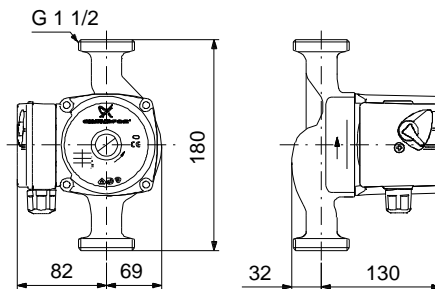
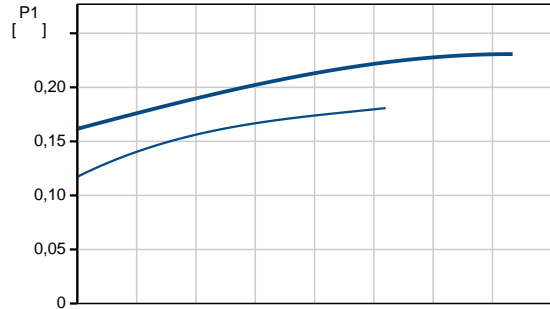
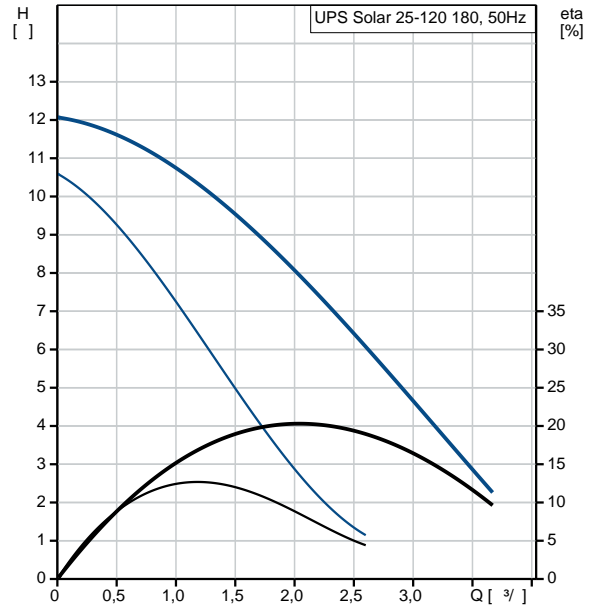

52588352 UPS Solar 25-120 180 50

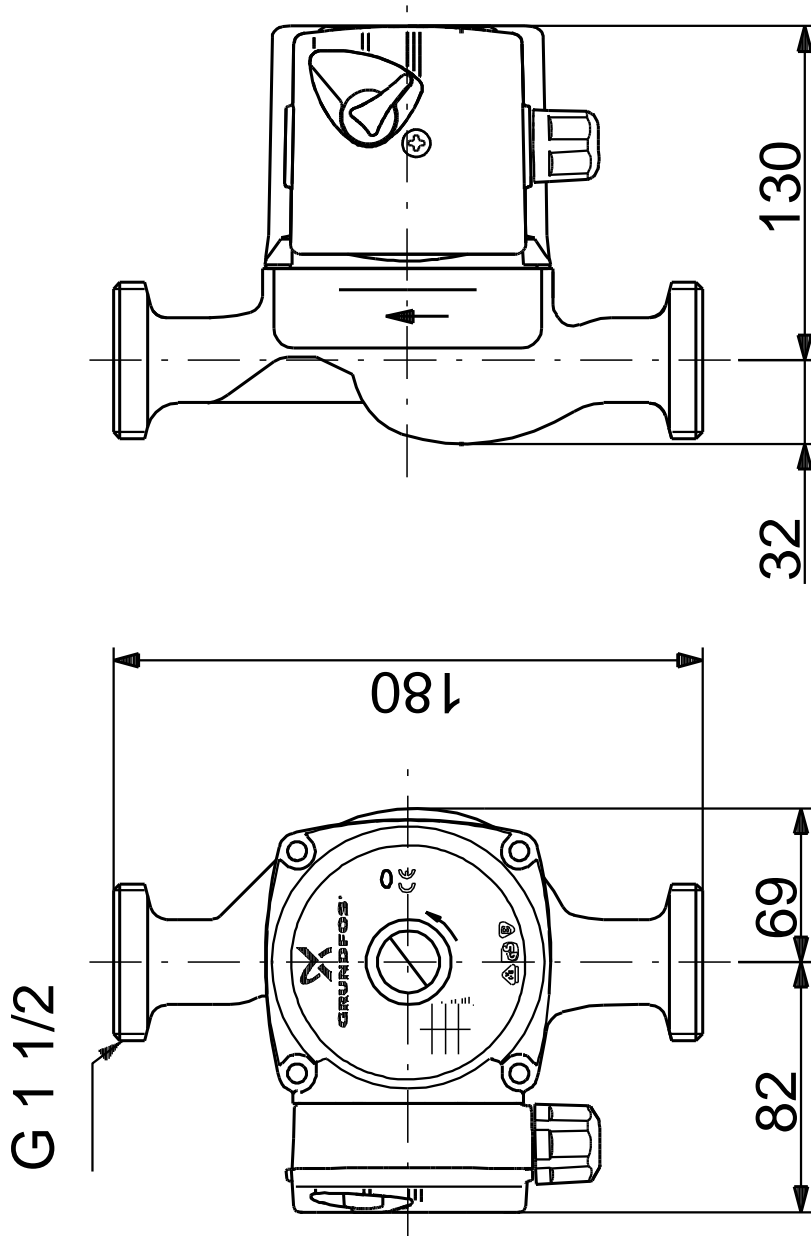

52588352 UPS Solar 25-120 180 50

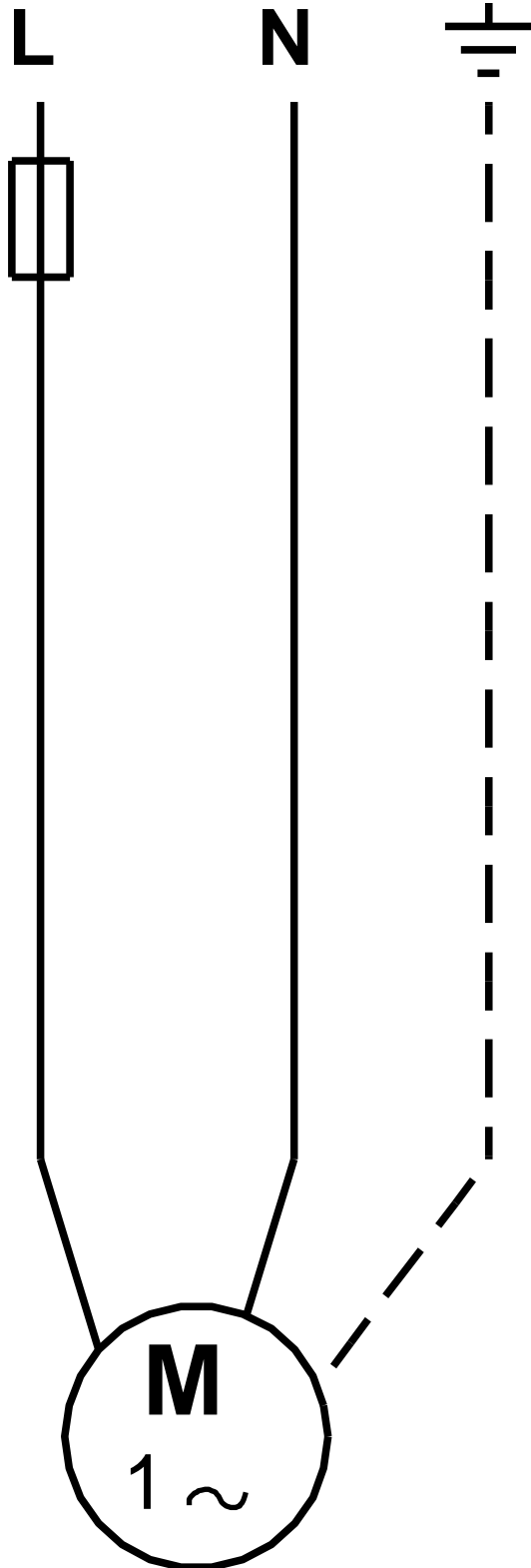

! [], .